

Axiom Transitions

Extruded aluminium sections to provide a seamless transition between plasterboard margins and suspended ceilings.

Key Features

- Designed for compatibility with different edge details using Axiom universal accessories for secure and easy installation
- Compatible with Zentia exposed ceiling grid systems including Silhouette and Interlude designer grids
- Plasterboard jointing flange for seamless integration with plasterboard ceilings
- Application Areas: perimeters

Physical Data

- Material: aluminium
- Surface finish: polyester powder painted
- Color: Global White
- Other colours available upon request

Product Range

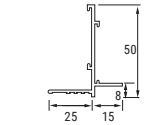

Item No.	Description	Dimensions (mm)		Standard Colours
		Length	Height	Global White
T 3208 G	Axiom Transitions for Tegular/MicroLook	3000	50	•
T 3219 G	Axiom Transitions shadowline channel	3000	50	•
T 3215 G	Axiom Transitions shadowline angle	3000	50	•
T 3210 G	Axiom Transitions for Vector tiles	3000	50	•
T 3228	Axiom Transitions channel	3000	50	•
T 3230	Axiom Transitions upstand channel 13mm board	3000	53	•
T 3271	Axiom Transitions angle	3000	51	•
T 3272	Axiom Transitions Channel for hook on metal tiles	3000	57	•

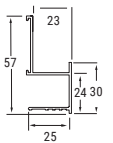
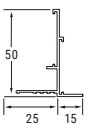
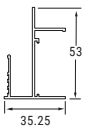
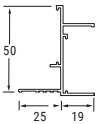
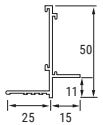
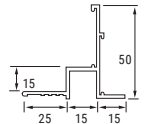
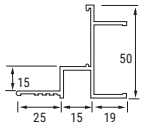

System Drawing

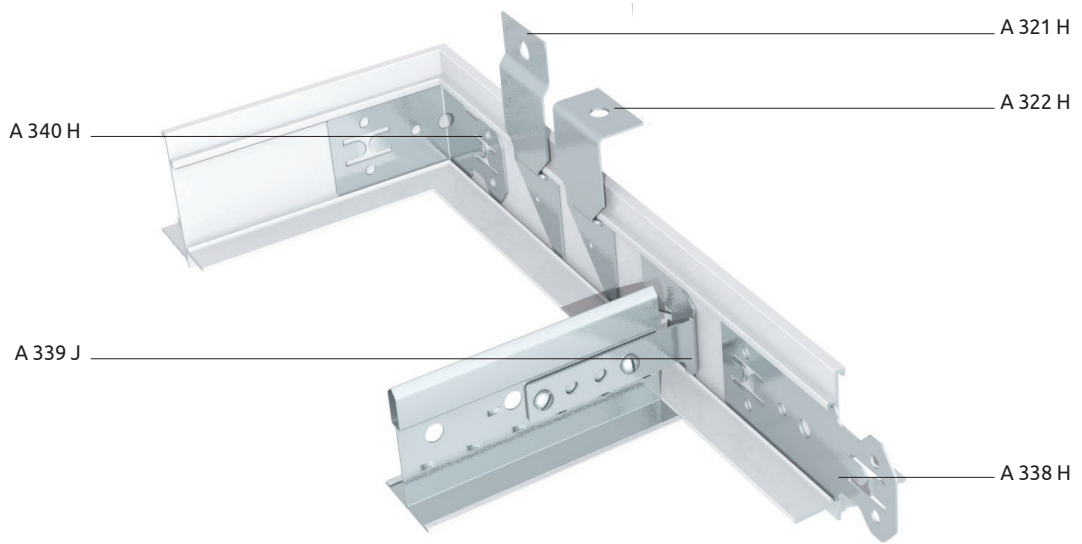

Cross Section

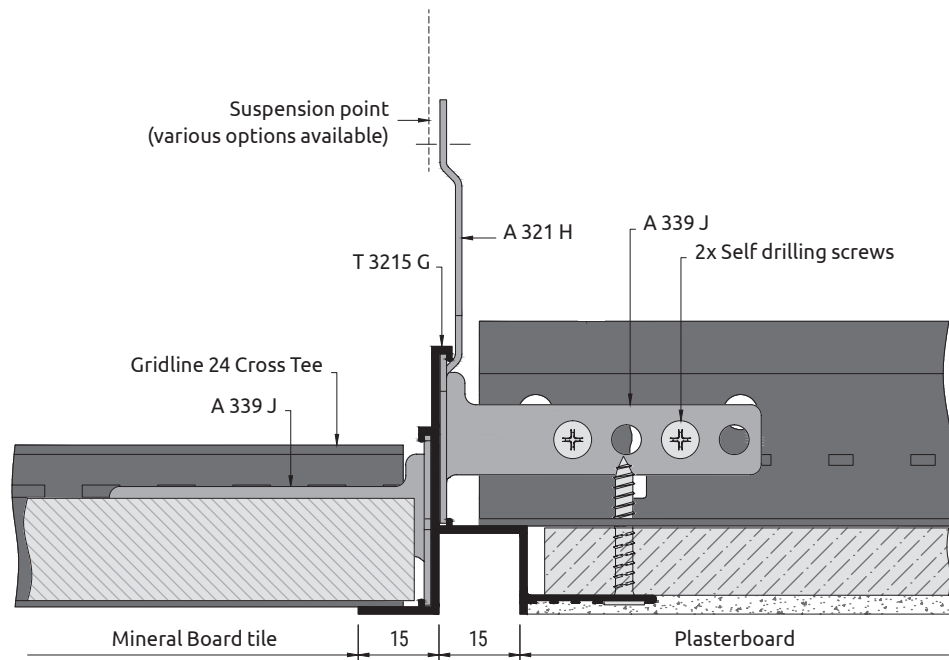

Sustainability



Fire Reaction



Other Performances & Features

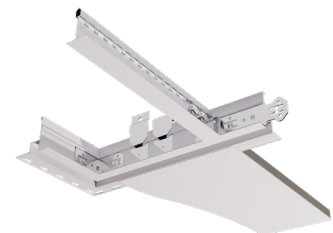

If you would like to order a sample or have any queries about this product please contact our Technical Sales Team on **0800 371 849** or email info@zentia.com

TDS 126.1.06.24