



Sonify Wall Absorbers

Mejora el acondicionamiento acústico de un espacio instalando Sonify Wall Absorbers.

Características Principales

- // Absorción acústica vertical optimizada que contribuye a una solución total para cada espacio
- // Péguelo directamente o utilice nuestro sistema de perfilaría de pared para una instalación rápida y eficiente
- // Combine varios paneles para crear una pared diferenciadora
- // Cada diseño se solicita con un kit asignado y se suministra como un "kit completo"
- // Disponible en una amplia gama de 35 colores y 7 formas distintas
- // Excelente rendimiento acústico: reduce los niveles de ruido, aumenta la inteligibilidad del habla y reduce el tiempo de reverberación en el espacio
- // Ideal para una multitud de entornos que incluyen hoteles educación, retail, oficinas y centros comerciales, entre otros

Producto **Wall Absorbers**

Medidas (mm)

RECTANGLE

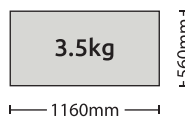
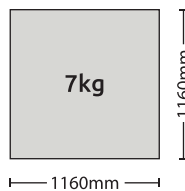
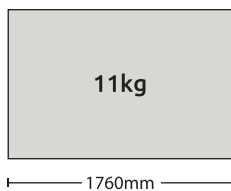
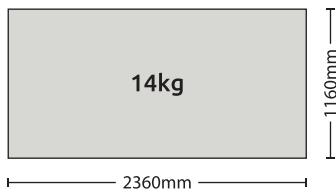

CIRCLE



HEXAGON

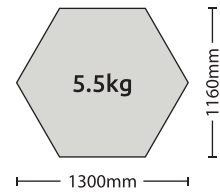

Espesor (mm)

40

Colores

Sonify blanco & 35 colores

Sostenibilidad



85%



EN 13964 / E1

Acústica



EN ISO 354
Y EN ISO 11654

Sonify Wall Absorbers ensayado en color blanco

Distancia montada desde la pared (mm)	Coeficiente de Absorción Acústica Hz α_p								
	α_w	Class	NRC	125	250	500	1000	2000	4000
25	1.00	A	1.00	0.40	0.85	1.00	1.00	1.00	1.00
enrasado a la superficie	1.00	A	0.95	0.30	0.70	1.00	1.00	1.00	1.00

Reacción al Fuego



Euroclass A2-s2, d0 (All colours)
EN 13501-1

Otras Características y Prestaciones



Estos componentes se utilizan para el sistema de perfilería Sonify Wall Absorber

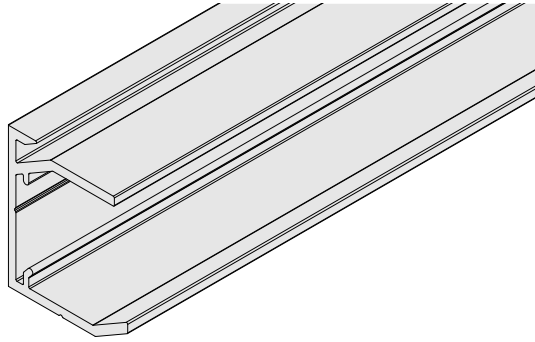

Perfil listel*

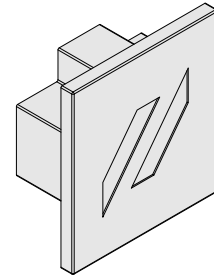

Wall Absorber Tapa final de perfil

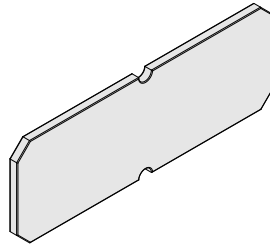

Placa de empalme de unión de perfil listel



Los plafones se pueden pegar a la pared directamente.

Zentia recomienda el adhesivo de agarre CT-1 Power Grab and Bond (PGB).

Si utiliza un adhesivo diferente, siga las recomendaciones del fabricante.

*Los tornillos los proporcionará el instalador, adecuados para fijar la el perfil listel a la pared

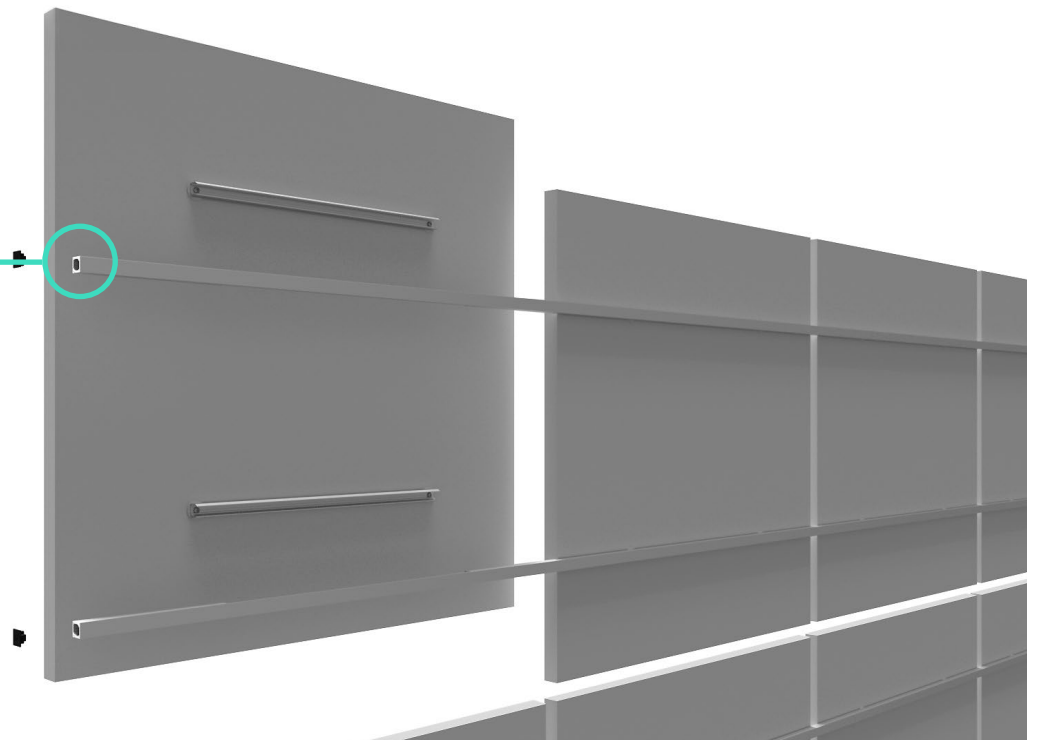

Sonify Wall Absorber con sistema de pefiles instalado

Gama de Colores

Sonify Wall Absorbers está disponible en los siguientes 35 colores:

 RAL 9003	 RAL 260 90 05	 RAL 130 90 10	 RAL 080 90 10	 RAL 050 90 10	 RAL 010 90 10	 RAL 340 90 05	 RAL 050 70 10
 RAL 000 85 00	 RAL 260 80 15	 RAL 130 80 30	 RAL 075 80 40	 RAL 050 80 30	 RAL 020 80 20	 RAL 340 80 20	 RAL 050 70 20
 RAL 000 65 00	 RAL 260 50 25	 RAL 140 50 30	 RAL 1003	 RAL 2009	 RAL 020 60 40	 RAL 340 60 35	 RAL 040 30 30
 RAL 000 30 00	 RAL 260 30 20	 RAL 140 30 20			 RAL 020 30 40	 RAL 340 30 30	 RAL 8004
 RAL 9005	 RAL 5015	 RAL 6037			 RAL 3020	 RAL 4006	

Recomendamos solicitar una muestra del color antes de especificar y realizar el pedido. Si desea solicitar una muestra o tiene alguna consulta sobre este producto, comuníquese con su contacto habitual en Zentia.

Tenga en cuenta que, aunque se ha tenido mucho cuidado para garantizar la correcta equivalencia de los colores, estos solo pueden ser tan precisos como lo permita el proceso de impresión. Cada monitor o pantalla móvil tiene una capacidad diferente para mostrar los colores, y cada individuo puede ver estos colores de forma diferente.



SOLICITE UNA MUESTRA



Si desea solicitar una muestra o tiene alguna duda sobre este producto, póngase en contacto con nuestro equipo técnico de ventas a través del [910 48 76 10](tel:910487610) o por email infoes@zentia.com

TDS 147.4.09.24